

DELISILICON

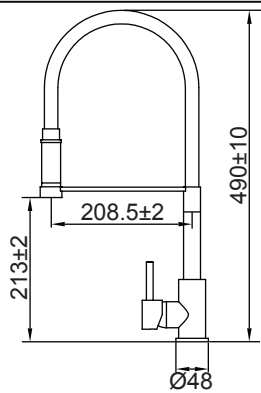

A

Ø48

D



E



F



G



B



C



H



①

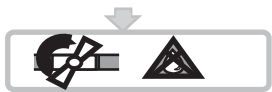
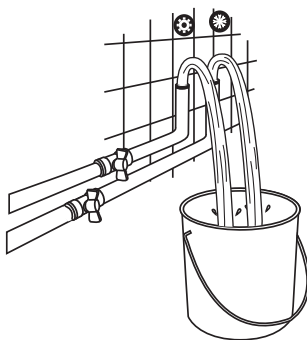

②

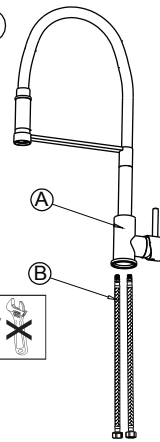

③

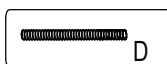
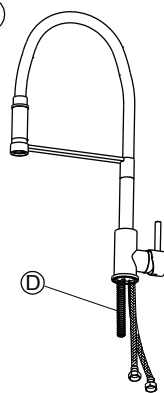

④

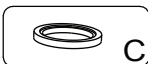
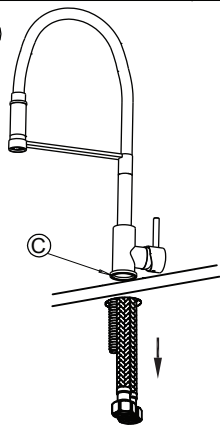

⑤

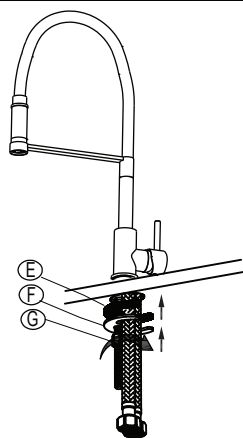

⑥

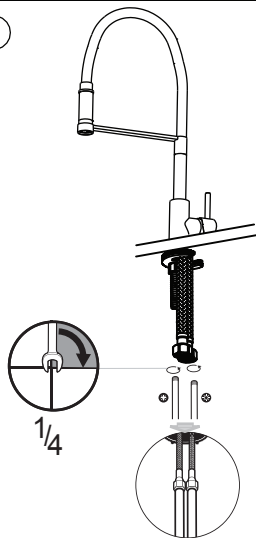

⑦

