

I CONDIZIONI DI ESERCIZIO

- Pressione dinamica minima.....1 bar
- Pressione di esercizio raccomandata (statica).....3 bar
(ATTENZIONE: per pressioni superiori a 5 bar si raccomanda di installare un riduttore di pressione)
- Pressione massima di esercizio (statica).....5 bar
- Pressione massima di prova (statica).....16 bar
- Temperatura massima acqua calda.....80 °C
- Temperatura raccomandata acqua calda.....65 °C (per sicurezza e risparmio energetico)

GB OPERATING CONDITIONS

- Minimum dynamic pressure.....1 bar
- Recommended operational pressure (static).....3 bar
(ATTENTION: when pressure exceeds 5 bar, we recommend the installation of a pressure reducer)
- Maximum operational pressure (static).....5 bar
- Maximum test pressure (static).....16 bar
- Maximum hot water temperature.....80 °C
- Recommended hot water temperature.....65 °C (for safety and energy saving)

F CONDITIONS DE SERVICE

- Pression dynamique minimum1 bar
- Pression de service recommandée (statique).....3 bar
(En cas de pression supérieure à 5 bar il est recommandé d'installer un réducteur de pression)
- Pression de service maximum (statique).....5 bar
- Pression maximum de test (statique).....16 bar
- Température maximum eau chaude80 °C
- Température recommandée eau chaude.....65 °C (pour sécurité et économie d'énergie)

D TECHNISCHE DATEN

- Minimaler dynamischer Druck1 bar
- Empfohlener Betriebsdruck (statisch)3 bar
(Bei mehr als 5 bar ist der Einbau eines Druckverminderers unerlässlich)
- Maximaler Betriebsdruck (statisch).....5 bar
- Maximaler Prüfdruck (statisch).....16 bar
- Maximale Warmwassertemperatur.....80 °C
- Empfohlene Warmwassertemperatur65 °C (zur Energieeinsparung)

E DATOS TÉCNICOS

- Presión dinámica mínima.....1 bar
- Presión de trabajo recomendada (estática).....3 bar
(N.B.: para presiones superiores a los 5 bar les recomendamos instalar un reductor de presión)
- Presión máxima de trabajo (estática).....5 bar
- Presión máxima de prueba (estática).....16 bar
- Temperatura máxima agua caliente.....80 °C
- Temperatura aconsejada agua caliente65 °C (para ahorrar energía)

NL TECHNISCHE GEGEVENS

- Minimum dynamische druk1 bar
- Aanbevolen bedrijfsdruk (statisch)3 bar
(N.B: in geval van druk, hoger dan 5 bar, raden wij u aan een drukvermindingsklep te installeren)
- Maximum bedrijfsdruk (statisch).....5 bar
- Maximum proefdruk (statisch).....16 bar
- Maximum warmwatertemperatuur.....80 °C
- Aanbevolen warmwatertemperatuur65 °C (voor energiebesparing)

EnergySave System

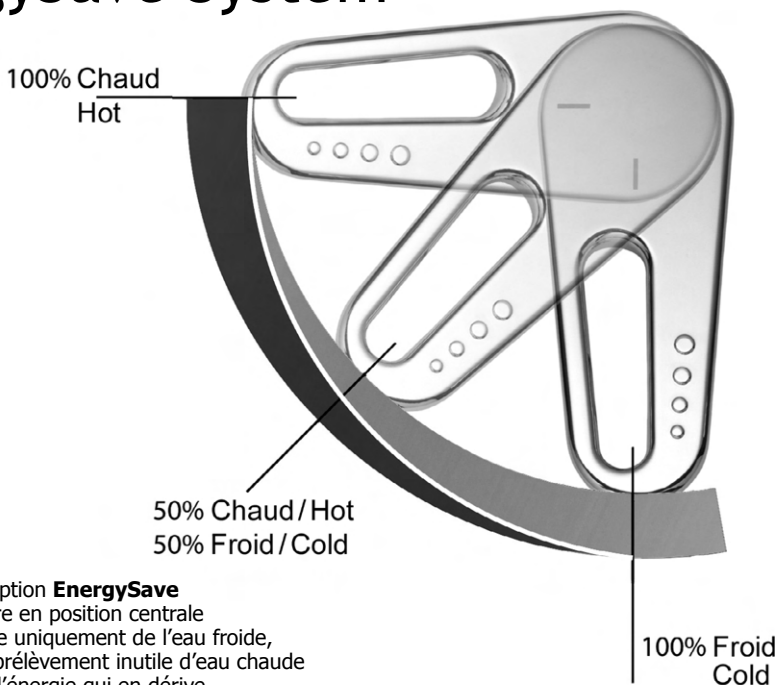

Grâce à la conception **EnergySave** lors de l'ouverture en position centrale le mitigeur débite uniquement de l'eau froide, évitant ainsi un prélèvement inutile d'eau chaude et le gaspillage d'énergie qui en dérive, au bénéfice d'une économie significative d'énergie. Le réglage de la température se fait normalement en tournant la manette vers la gauche, jusqu'à obtenir la température maximum souhaitée.

With **EnergySave** System, when opening with lever in central position the mixer delivers cold water only, thus preventing the water heating system from starting. This grants a significant benefit in energy and cost saving.

Whater temperature regulation is normally operated by turning lever left, towards adjustable maximum temperature position.

Con il dispositivo **EnergySave**, all'apertura con leva in posizione centrale il miscelatore eroga unicamente acqua fredda, evitando così l'inutile accensione della caldaia e il conseguente spreco di acqua calda, con il beneficio di un notevole risparmio energetico ed economico. La regolazione della temperatura avviene normalmente ruotando la leva verso sinistra, fino alla temperatura massima desiderata.



Non incluso / Not included / Non inclus / Nicht Dabei / No incluido / Nitinbegrepen



Incluso / Included / Inclus / Dabei / incluido / Inbegrepen

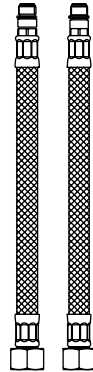
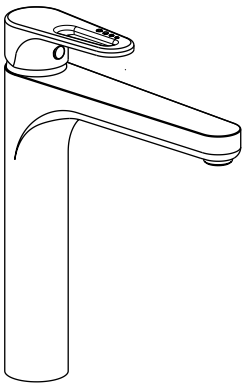

B1



A1



A2



A3



A4



A5



D1

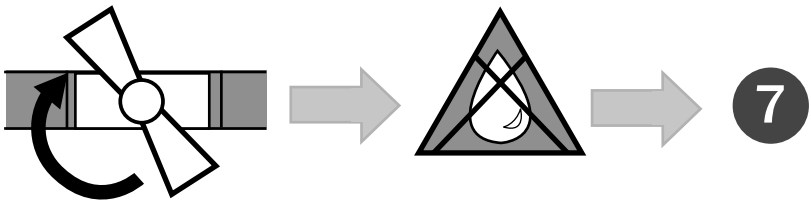
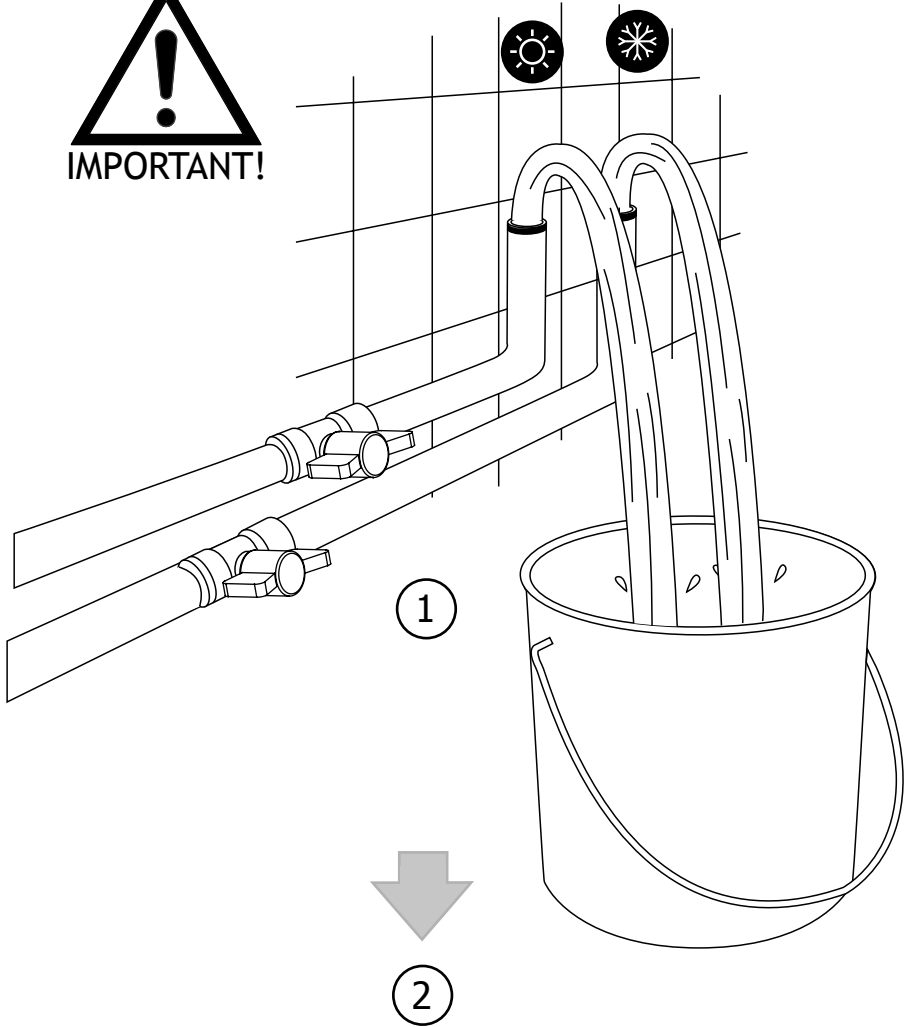

7

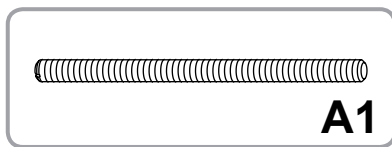
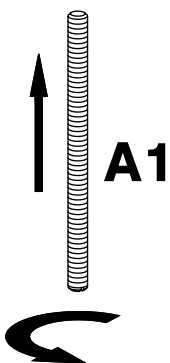
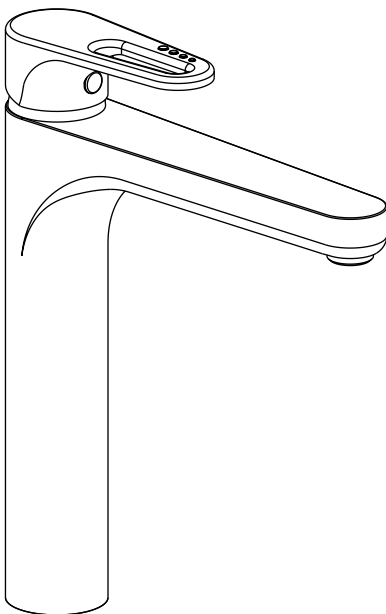

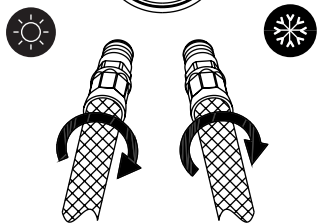
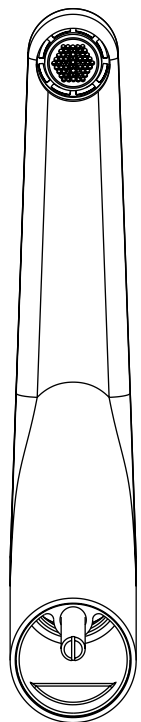

B1 ↑ ↑ **B1**

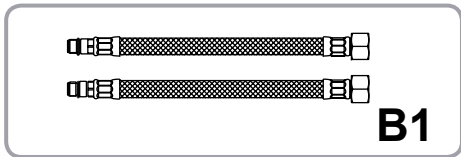

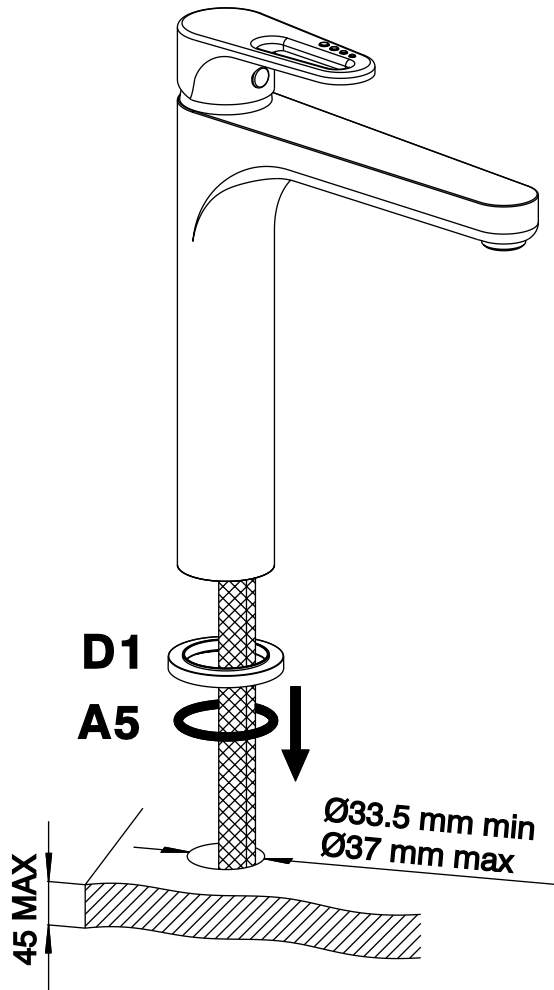
**D1****A5**

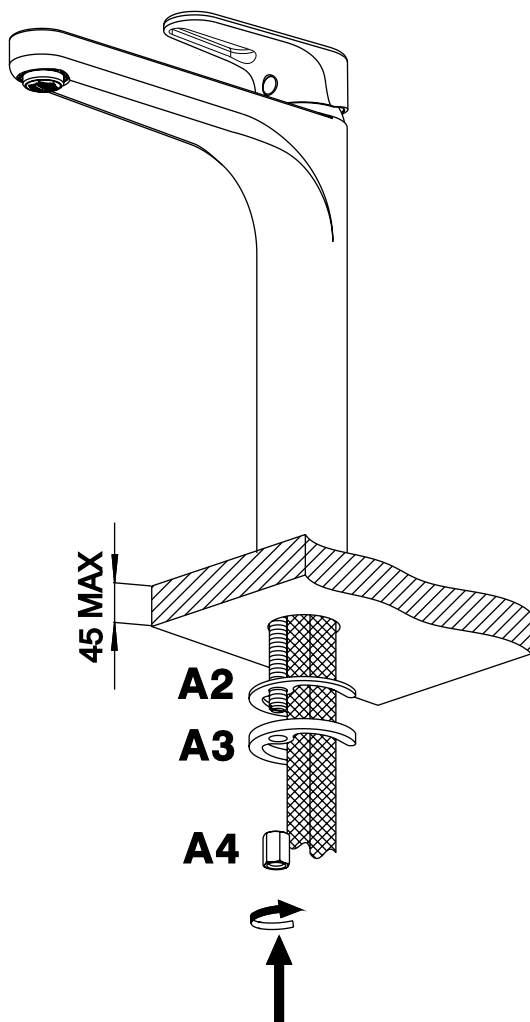
**A2****A3****A4**

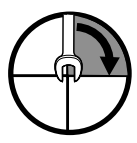
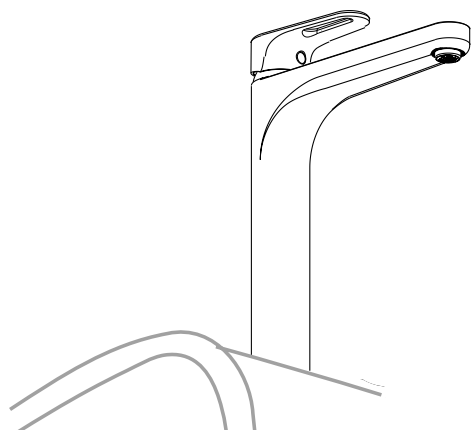

1

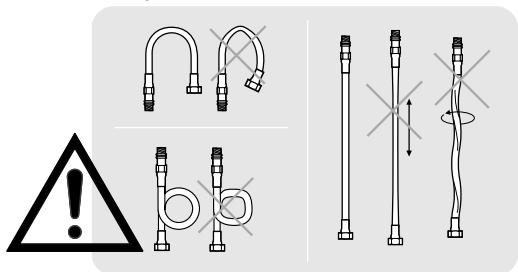
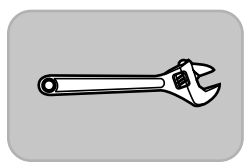
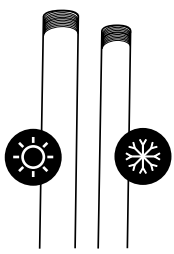
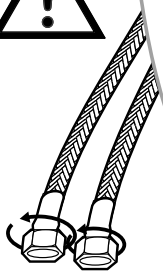

2

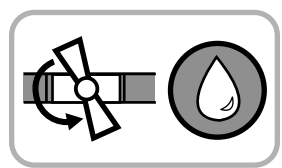

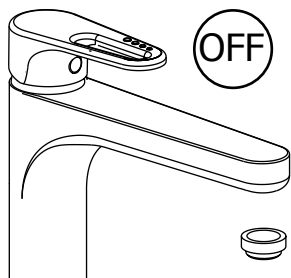
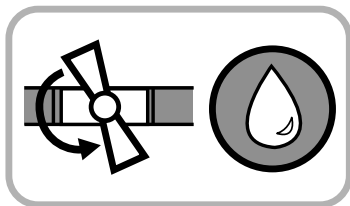

1

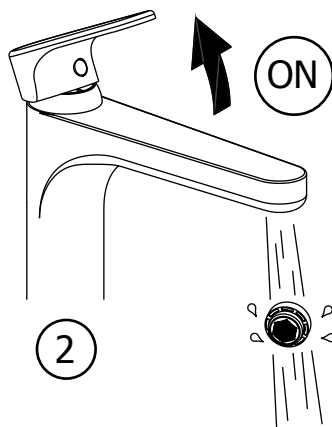
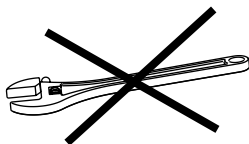
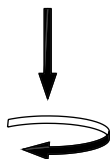

2

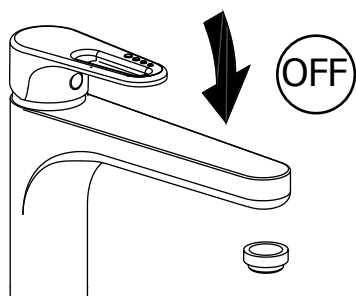

3

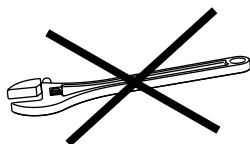
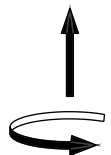

Non incluso / Not included / Non inclus / Nicht Dabei / No incluido / Nitinbegrepen

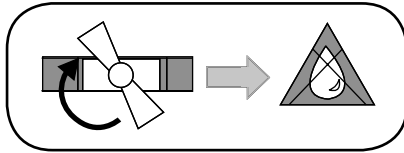
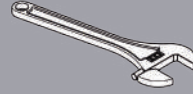
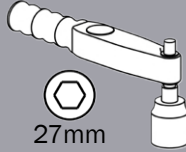

1

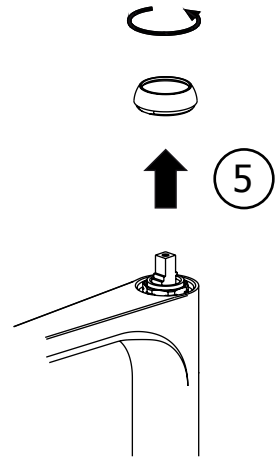
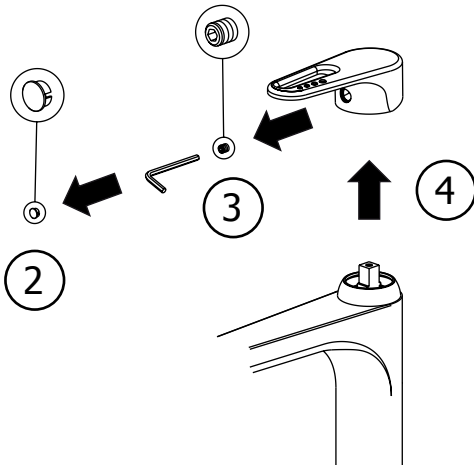

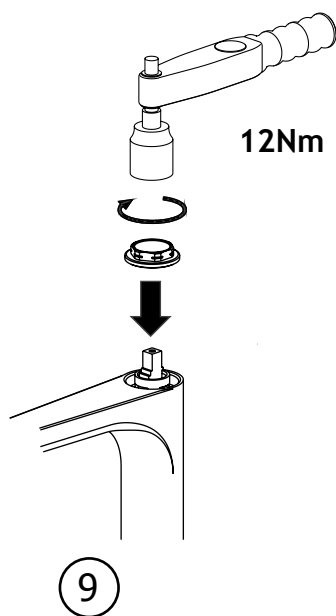
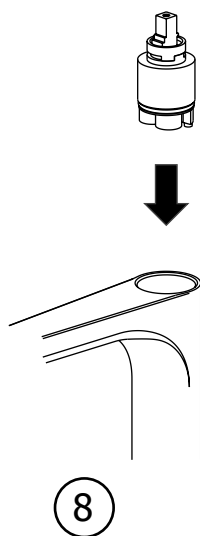
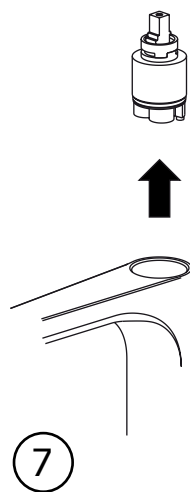
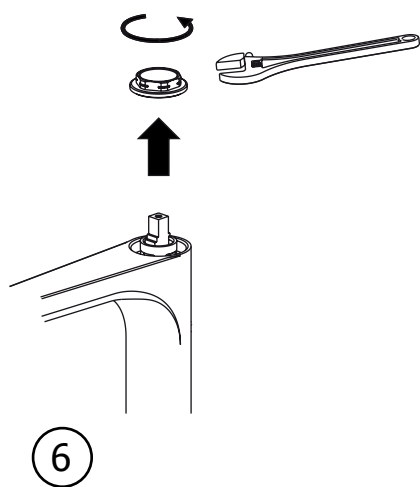

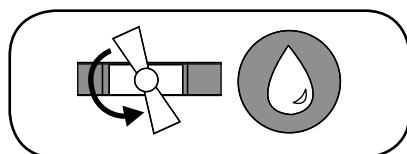
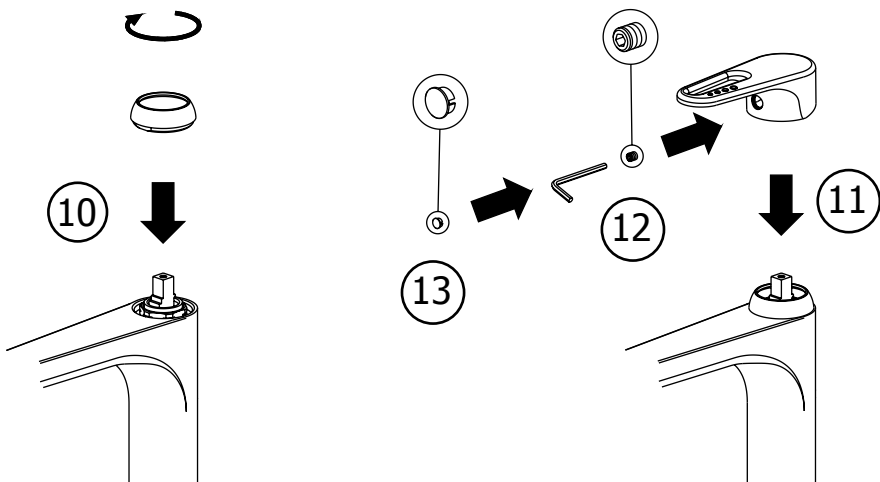

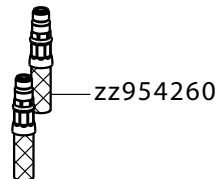
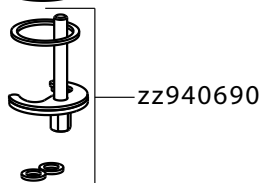
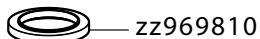
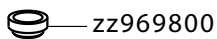
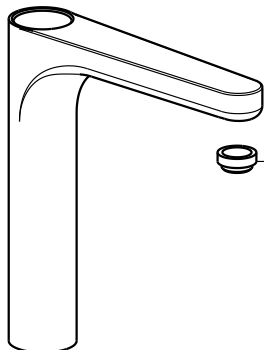
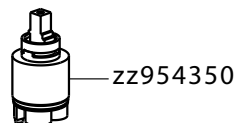
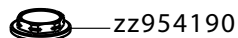
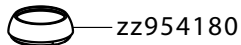
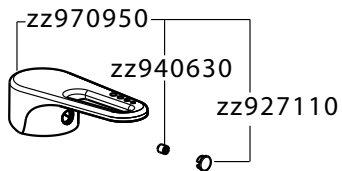
**BALMA****Réf.****3661109007535**