

COMBI DOUCHE

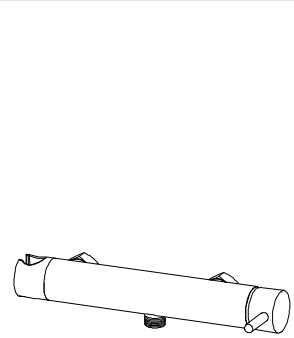

B

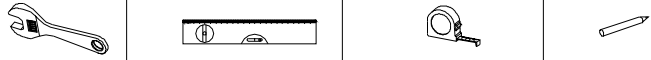

C



D

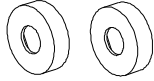

E



F

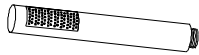

A

①

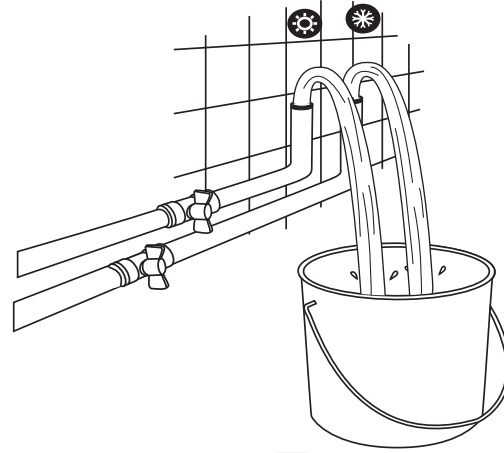

②

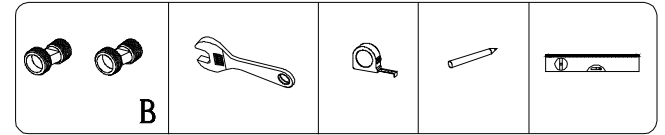
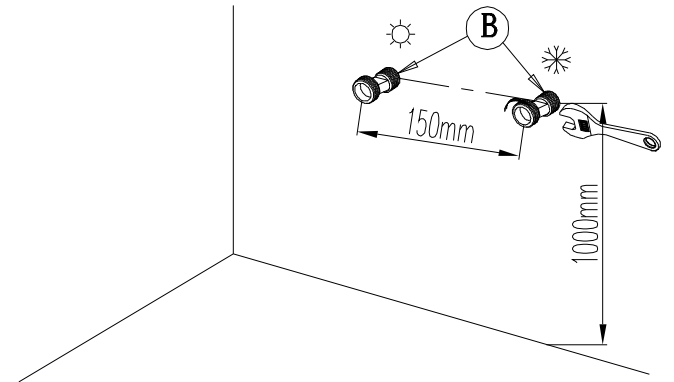

③

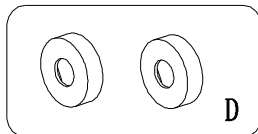
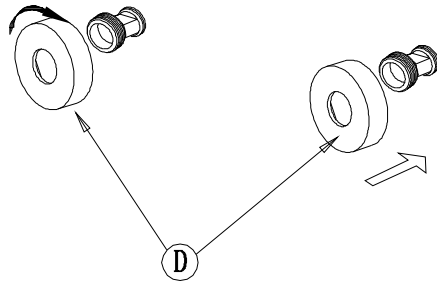

④

